

This fact sheet offers insight into battery electric propulsion, ranging from relevant regulations, technical concepts, information on economics and environmental sustainability as well as references to deployed examples. Batteries can be used as the sole power source or in combination with a more conventional, e.g. Diesel-electric drivetrain.

## FACT SHEET N° 5

# BATTERY ELECTRIC PROPULSION



*Picture used with courtesy of SENDO Shipping*

*The sole responsibility lies with the author. The European Union is not responsible for any use that may be made of the information contained therein*

In cooperation with



**Edition April 2020**

### INTRODUCTION

Ship operation without local emissions of air pollutants and CO<sub>2</sub> can be realised with electric drives based on batteries and/or fuel cells. While electric drives are common since decades in the railway sector based on catenaries or conductor rails, modern electro mobility on the road virtually emerged few years ago and is spreading quickly. Electric cars and urban busses are becoming technically and economically more and more competitive, even though the cruising range is still limiting for many applications. In inland navigation the limitations regarding volume and mass often are less critical than for road vehicles. However, the requirements in terms of power and capacity are challenging. Additionally, the lifetime, investment costs per capacity, charging infrastructure and the sustainability of the supply chain require a detailed assessment for individual applications.

Nevertheless, batteries will be used more and more in different applications of inland navigation. Smaller passenger vessels or car ferries with limited range of operation in densely populated areas are most suitable for early adoption. Even long haul cargo vessels can benefit from batteries and reduce emissions and exposure of the population to air pollutants temporarily. Batteries with moderate capacity can be used to switch off combustion engines of x-electric ships while operating in ports, passing sensitive areas or when berthed. Incentive schemes like the Dutch Green Award level Platinum with reduced fees for ships capable of several hours of emission-free operation contribute to business cases for these hybrid drivetrains.

Depending on requirements of the individual application, batteries may be permanently installed on the ship or exchangeable. Batteries in standardised ISO containers can be replaced and handled with common port equipment. This model does not require powerful electric infrastructure and time for charging at the quay. It even allows alternative business models, referred to as “energy as a service” or “pay per use”, where utility companies invest in the battery containers and charge the batteries, possibly stabilizing the electric grid. Ship owners and operators only pay for the energy used. As long as the charging infrastructure for propulsion batteries permanently installed is not sufficient, emissions and exposure can be reduced even if the batteries are charged during operation with gensets. This requires a smart power management on board of the ships to run the gensets at optimum load. Hybrid systems of growing complexity will be installed more frequently during the coming decades. Almost all systems with fuel cells or solar panels etc. require batteries for peak-shaving and buffering of energy.

### REGULATIONS

The **European Committee for the Development of Standards in Inland Navigation (CESNI)** has already compiled in 2017 a chapter called **Requirements for Electrical Appliances and Installations (Chapter 10)** in the **European Standard for Technical Requirements for Inland Navigation Vessels (ES-TRIN 2017)**. Further, in 2019 Chapter 11 **New requirements for electrical propulsion systems** was added to **ES-TRIN 2019**.

For the use of lithium-ion batteries, the requirements of the European Standards **EN 62619:2017** and **EN 62620:2015** can be applied.

Lithium-ion batteries shall be equipped with systems which include at least the following functionalities:

- Cell protection (short circuit external, internal, overcurrent, deep discharge, etc.)
- Charge control, if not via the charger
- Load management
- Determination of the state of charge
- Balancing the cells
- Thermal management

If a classification of the vessel is necessary, there are also additional rules from the classification societies available. Due to the general regulations of ES-TRIN an electric propulsion system must consist of at least two separated power supply systems, one main switch board, one frequency converter and one electric motor on the propeller shaft. One of the systems must be able to ensure a safe ship operation for at least 30 minutes in case of a failure of the second battery system. It must be ensured that the capacity of batteries or accumulators shall enable the safe reaching of a berth under the craft's own power at all times and under all conditions.

According to the **ES-TRIN 2019**, Chapter 10 and 11, the batteries must be located outside of apartments, holds, wheel houses and passenger cabins. Furthermore, they must be protected against extreme temperatures and water. Charging devices must be designed to charge the battery within a maximum of 15 h to 80 % of its nominal capacity without exceeding the maximum allowed charging current of the battery. The charging device must be specified to charge the selected type of battery.

The electric propulsion motors must be designed according to their operational profile including temporarily overloads and the effects of manoeuvres. The power electronics for electric propulsions must be designed for the anticipated loads, including overload and short circuit, during all operating and manoeuvring conditions. Finally, the operating state of the electric vessel propulsion and its principal components has to be displayed in the wheelhouse and in the propulsion installation. If this monitoring has a malfunction, the current state must be observable on site of each component.

### TECHNICAL CONCEPT

The battery electric propulsion system consists of rechargeable batteries, electric switch board and an electric propulsion system.

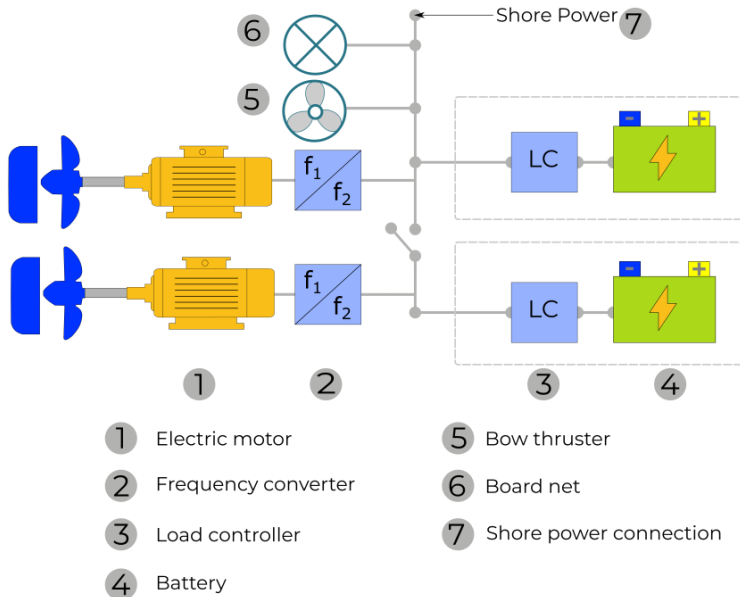

The electric motor (1) drives the propeller with constant rpm (revolutions per minute) at any load case. Its advantage is a nearly constant efficiency at all load cases. Depending on the selected electric motor a gear box can be omitted. The frequency converter (2) supplies the electric motor with a frequency and voltage amplitude variable AC voltage. The converter can be supplied by any AC or DC on board energy grid. The rotational speed of the electric motor is controlled by varying the output frequency. The load controller (3) distributes the energy from all sources to all loads. The loads are frequency converters at the propulsion systems, bow thruster (5), board net (6), pump systems, etc.. It can be designed as a single AC or DC rail, which can be split in a starboard and portside system. The batteries (4) can be charged via a shore power connection (7).

A battery is an electrochemical energy storage device and a converter that provides the flexibility and freedom to store unused or excessive energy and then use the energy to benefit the operation of the ship. The electrical energy is stored by chemical reactions that are electrically driven. Batteries are basically divided into primary and secondary batteries. With primary batteries, the chemical energy is converted into electrical energy once, while secondary batteries (accumulators) can be repeatedly discharged and recharged. To recharge the accumulator the chemical reaction is returned by a voltage application. There is a loss in heat leading to different temperatures in the battery and an acceleration of aging. In the following only secondary batteries, known as accumulators, are treated.

### BATTERY TYPES

Beside all varieties of different batteries, they all share about the same construction. A battery cell consists of two electrodes, the negative anode and the positive cathode, which are enclosed by an electrolyte. The electrolyte can be made of liquid, gel or solid materials. For both electrodes and electrolyte different chemical matters are used. The current negative charge converts from the cathode to the electrolyte while the anode absorbs it. The process is triggered by the electrolysis (see fact sheet fuel cells). The whole chemical reactions happen at the surface of the electrodes. The chemical active material diffuses through pores of the electrodes, reacts with the electrolyte and has to be transported. Otherwise the reaction is broken because the capacity of the cathodes is limited. That would lead to an increase of the discharging current. Often there is a separator used between the electrodes. The separator is semi-permeable, meaning that the ions are able to pass the separator while the electrons are filtered. The cell voltage and electrical characteristics depend on the electrochemical potential of the electrodes' materials. Usually, a battery consists of multiple cells, to increase the battery voltage and capacity.

Discharging of a battery means to convert chemical energy to electrical energy. If the battery is discharged more than the specific value of the final discharge voltage, a damage of the battery is possible. In addition to that a self-discharge process of a battery caused by undesirable reactions in it has to be taken into account. For charging a battery, current has to be spread. All reactions are returned but the controlled reversal is not perfect for most cases. Therefore, the number of charges is bounded.

### LEAD-ACID BATTERIES

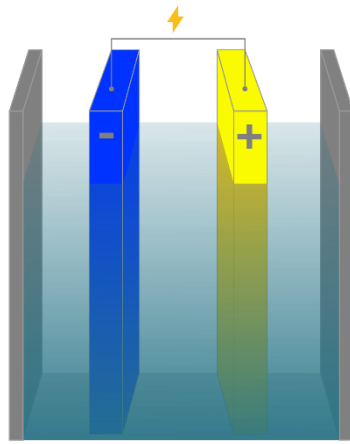

■ Lead Anode  
■ Electrolyte (Sulphuric Acid)  
■ Lead Oxide Cathode

The lead-acid cells have a nominal voltage of 2 V. Both electrodes are made of lead; sulphuric acid is used as electrolyte. This battery type is approved by more than a hundred years of practice and further development. It is the current state of art for power backup system on board. These batteries require only little maintenance and are excelled by a long lifetime. The service life is up to approx. 2,000 cycles. A disadvantage of this type is its low energy density. For high capacitive battery systems a lot of space and displacement reserve must be available on board. Generally, lead-acid batteries can supply very high discharge currents, particularly in short-term. The charging current is quite low compared to the discharge currents. This requires a long time span at the pier to charge the batteries.

- |                   |          |          |
|-------------------|----------|----------|
| • specific energy | [Wh/kg]: | 25 – 50  |
| • energy density  | [Wh/l]:  | 50 – 100 |
| • power density   | [W/kg]:  | 75 – 300 |

### LITHIUM-ION BATTERIES

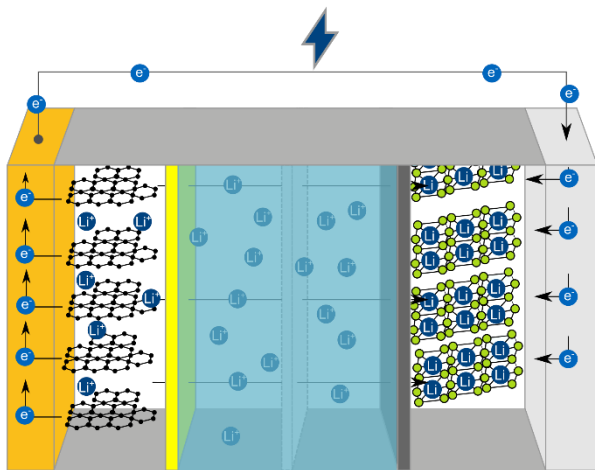

■ Copper Collector  
■ Graphene Anode  
● Lithium Ion  
■ Solid Electrolyte Interface  
■ Elektrolyte Separator  
■ Cathode Electrolyte Interface  
■ LiMO<sub>2</sub> Cathode  
■ Aluminium Collector

There are various electrode combinations for lithium-ion (Li-ion) batteries. The materials used are influencing important properties of the batteries, because of their different electrochemical potentials and chemical characteristics. The "lithium nickel manganese cobalt dioxide" and the "lithium iron phosphate" batteries are essentially considered here. Lithium is the smallest and lightest metallic element. Compared to lead-acid batteries, it is the ideal raw material for much lighter and more powerful energy cells. The nominal cell voltage is approx. 3.6 V, varying by the used electrode materials.

Li-ion cells are particularly popular because of their advantages in terms of storage capacity, cycle stability, self-discharge rate and high energy density. Beside high discharge currents, high charge rates can be applied too. However, they are relatively temperature sensitive. The ideal operating temperature is between 10°C and 35°C. In order to ensure the longest possible battery life, the charging process must be controlled by power electronics.

- |                   |          |            |
|-------------------|----------|------------|
| • specific energy | [Wh/kg]: | 180 – 260  |
| • energy density  | [Wh/l]:  | 200 – 350  |
| • power density   | [W/kg]:  | up to 5000 |

### BATTERY SYSTEMS

Maritime battery systems typically consist of several thousand cells. It is, therefore, important that each cell works consistently with all other cells. The individual battery cells are interconnected to form battery modules, whereby the required voltage is reached. Due to the networking of these units, large systems with a high capacity can be assembled. The battery systems can be integrated into the hull of the ship or can be installed in separate battery cabinets.

A superordinate battery management system collects the information on all modules of the containers and makes it available to the skipper. At the same time, the management system coordinates the charging and discharging processes in order to optimise the service life of all cells. The battery cabinets must be air conditioned, to keep the cells within an optimal temperature range.

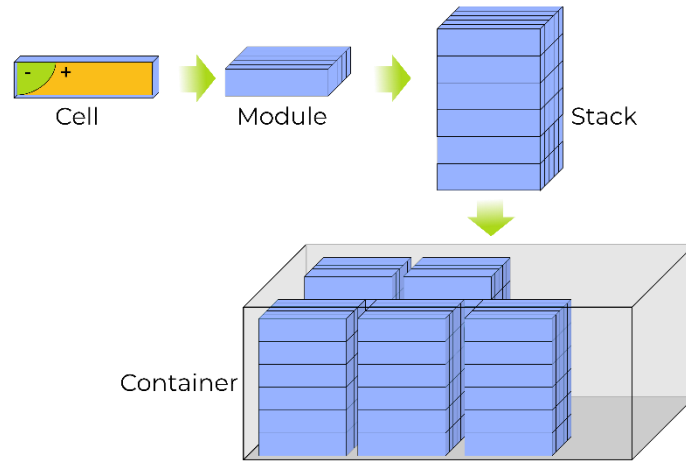

### CHARGING POWER AND NETWORK LOAD

In addition to the batteries on board, the ship must also be equipped with the control technology for the charging process. For charging the battery via the shore connection of the ship, the requirements of DIN EN 16840 must be fulfilled. Within these standards electrical installations for supplying inland waterway vessels with electrical energy, 400 V, 50 Hz and a current strength of at least 250 A are described.

#### Charging time

The charging time of a battery depends on various factors. There are different possibilities for charging, which also affect the type of installation in the ship. Sufficient power must be available both for the electric load on board, possibly including e.g. reefer containers, and for batteries to be charged. A generally valid determination of the charging time as a function of the charging capacity and the battery capacity to be charged is defined by the C-rate. The C-rate defines the charging or discharging power as a function of the battery capacity. 1 C corresponds to a charging power at which the battery is fully charged in one hour.

Often there are different phases of charging. Firstly, the battery is protected by charging it slowly to test whether the final discharge voltage is below the critical threshold. After that the most part of the energy is supplied. At least the rest of missing energy is added. For taking care of the battery the intensity of the current is degraded. During the charging process, there is always a loss in heat and during further side reactions.

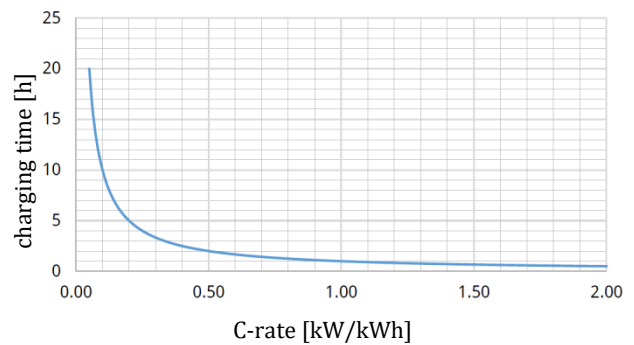

$$C - rate = \frac{\text{charging power}}{\text{battery capacity}}$$

### DEGRADATION MECHANISMS AND LIFETIME

The service life is a very important aspect of the energy storage system. It is difficult to determine the exact length of the lifetime because many factors play a role. One important factor to extend the lifetime of batteries is the depth of discharge (DoD): If a battery is very often discharged to very low levels, the lifetime of the battery will decrease. To achieve a good performance of the battery for several years, the capacity should be planned to be at least 20 % higher than the required capacity. This design ensures a low DoD and a careful usage of the battery. In any case of emergency, the battery can provide more power than the capacity required for normal operation. This ensures a safe operation of the ship, even if the planned DoD is reached. The service life itself is less often measured in time, rather in charging and discharging cycles.

A cycle results from the charging and discharging of a battery and is completely achieved when the amount of energy corresponding to the storage capacity has been completely used. Using smaller batteries with a higher amount of charging and discharging cycles is less expensive at the initial investment costs, but leads to a shorter lifetime and an earlier need for reinvestments. On the other hand, if a ship is capable to have twice the capacity installed, the lifetime of the batteries is twice as long as the lifetime of the smaller batteries, but the initial investment is higher.

### ELECTRIC PROPULSION SYSTEM

The electric propulsion system must consist of a suitable electric propulsion motor connected with the propeller shaft and a compatible speed controller.

#### ASYNCHRONOUS MOTOR

The asynchronous motor is the most widely used industrial motor. It can be connected directly to the three-phase mains and is very robust and easy to build. The asynchronous motor takes its name from the fact that it does not rotate exactly with the mains frequency. It only has a torque if its speed deviates from the synchronous speed. In the operating range, the torque is proportional to this deviation. This type of electric motor is characterized by low investment costs and small dimensions. Its nominal rate of revolutions is usually too high to be used as a direct drive. A gearbox between electric motor and propeller shaft is necessary. The gearbox increases the investment costs, lowers the efficiency of the drive train and could be a point of failure. If the advantages of asynchronous motors and the disadvantages of the gearbox are balanced correctly, a cost and energy efficient drive train can be designed.

#### SYNCHRONOUS MOTOR

For synchronous motors, the speed of the motor is equal to the mains frequency divided by the number of pole pairs. The rotor of a synchronous motor is permanently magnetized and follows the rotating field of the stator with a phase difference. Usually, the speed is given in revolutions per minute (rpm). This type of electric motor is characterized by high energy efficiency, low nominal rate of revolutions and a good torque/speed characteristic. This motor can be used as a direct drive, without a gearbox between motor and propeller shaft. Its large outer dimensions are disadvantageous like the high investment costs. Using a synchronous electric motor for the propulsion system leads to an efficient drive train with a sensitive control.

### REQUIREMENTS FOR THE CHARGING INFRASTRUCTURE

For re-charging via a shore power connection there are two types of construction available:

- Electric charging station with integrated single-core sockets
- Electric charging station with spatially separated transfer station with integrated single-core sockets

The required infrastructure for battery systems essentially consists of suitable charging stations or suitable crane systems for ISO containers for changing battery packs. The dimensions specified in standard 668 and the maximum weight of approx. 30 t should not be exceeded by the container.

The existing shore power infrastructure is usually too weak for loading large batteries. The operators of the electrical power grids at the quay edge would have to provide connected loads in the megawatt range. In the background, the energy must be provided in the entire electrical network by power plants.

For charging the batteries on board, the existing low-voltage grid with 400 V three-phase current seems unsuitable. Due to the relatively low voltage, a high current must flow for high charging capacities. To transport large currents through a cable the connection cables must have a large cross-section.

### ECONOMICS AND ENVIRONMENTAL SUSTAINABILITY

#### INVESTMENT COSTS

Cost category	Exemplary costs
Battery	500 EUR/kWh
Electric motor	120 EUR/kW
Installation costs	30,000 EUR for conversion, wiring and power management

#### ECONOMIC OPERATIONS

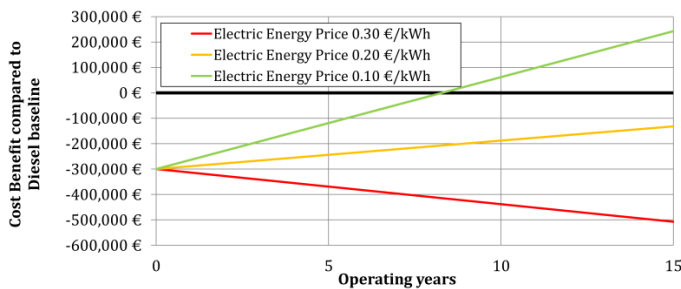

The amortisation time of the battery depends on the electricity price. Reduced or no taxation of electric energy for shipping are discussed as well as new cost models like “energy as a service”. In that case, the ship would lease the battery and pay for the electricity consumed. The example is calculated for a ferry with an annual energy demand corresponding to 100 m<sup>3</sup> diesel. The installed battery would provide energy for one day of operation.

#### BENEFITS

- Good controllability
- Good ability to retrofit due to modular design
- Increased comfort (noise and vibrations)
- Low maintenance
- Near-zero local emission of CO<sub>2</sub> and air pollutants
- Reduced noise emissions
- High development potential
- Low operating costs
- Potential of renewable energy as a source

#### DOWNSIDES

- High investment costs
- Operating experience in field test still low
- Shorter service life to market-dominant products (combustion engine)
- Few suppliers
- Due to lower energy density, more weight and space for the same energy storage compared to combustion fuel
- Restricted operating range due to battery capacity

#### ENERGY DENSITIES

The graph compares the energy densities of lithium-ion batteries, lead-acid batteries and diesel fuel. It can be seen that the storage of the same amount of energy in a battery rather than in diesel requires both more space and weighs more.

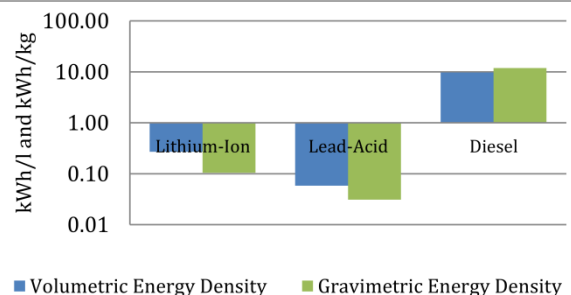

#### ENVIRONMENTAL SUSTAINABILITY

Accumulators with a high living cycle are the better choice in terms of environmental sustainability. In comparison to combustion engines, electric ones do not emit exhaust in operation; therefore local exhaust can be reduced or omitted. However, for an overall environmental analysis, also the power generation has to be taken into account. Since not all the power is yet provided by renewable energy, the total benefit has to be seen critically. Nevertheless, with the expected increasing share of renewable energies, the balance will get positive.

The materials used for the accumulators, with regard to the acids used as the electrolyte, can be (if leaking) extremely harmful for water organisms.



### CONSIDERATIONS FOR DEPLOYMENT

The battery industry is working on alternative and more advanced batteries, which are lighter as well as with a higher energy density and cycle stability. Examples for that are graphene batteries and silicon air batteries.

Ships which have to travel far distances could be advanced with solar panels to constantly recharge the battery system. This system could also be applied to ships travelling a short distance to eventually eliminate the recharging process in harbours completely in order to save time and improve the river transport economically.

### DEPLOYMENT EXAMPLES

#### SANKTA MARIA II

**Operator:** local congregation Oberbillig  
**Location:** Germany, Oberbillig  
**Organisers:** local congregation Oberbillig  
**In operation:** 2015  
① [www.oberbillig.de](http://www.oberbillig.de)



Oberbillig. In addition, 15 solar modules with 360 W each and a total output of 5.4 kW are installed on the ferry, the solar power is fed into the batteries for the 24 V onboard power supply.

**Benefits:** Battery capacity of 6.5 h drive at 5 km/h, charging 5 hours

**Vessel type:** ferry

**ENI:** 04813080

**Vessel size:** 28.0 m × 8.6 m (L × W), Draught: 0.83 m

**Propulsion:** All-electric ferry driven by 4 Sail-Drive electric motors with 20 kW each. The electricity for the electric motors comes from two lithium polymer battery blocks with a capacity of 252 kWh, which are charged daily via a 63 A shore power connection in

#### SENDO LINER

**Operator:** Sendo Shipping  
**Location:** Netherlands  
**Organisers:** Sendo Shipping, Concordia Damen, EST-Floatech, Oswald Elektromotoren  
**In operation:** 2019  
① [www.sendo-shipping.nl](http://www.sendo-shipping.nl)



charged with the generators. About 95 % of the time only one of the two generators is used. The battery pack ensures that the vessel is able to sail for up to 3 hours without emissions. The battery pack also serves as a buffer when more power is needed temporarily.

**Benefits:**

- No local emission of CO<sub>2</sub> and air pollutants in sensitive areas
- Reduced noise level onboard and reduced noise emissions to the environment
- Reduction of fuel consumption and CO<sub>2</sub> emissions compared to similar vessels by 32 %

**Vessel type:** inland dry cargo vessel

**ENI:** 02338022

**Vessel size:** 110 m × 11.45 m (L × W), Draught: 3.2 m

**Propulsion:** Diesel-electric drive in combination with a battery pack: two electric motors of 350 kW each driving the propellers, two generators of 430 kW each are installed in the bow. The battery pack has a capacity of 564 kWh and is usually



### Contact

For further information or suggestions how to improve this fact sheet please do not hesitate to contact:

**DST – Development Centre for Ship Technology and Transport Systems**

Oststraße 77  
47057 Duisburg, Germany

Phone: +49 203 99369 29

Fax: +49 203 99369 70

E-Mail: [Friedhoff@dst-org.de](mailto:Friedhoff@dst-org.de)

Web: [www.dst-org.de](http://www.dst-org.de)